

# Non Separable 3D Lifting Structure Compatible with Separable Quadruple Lifting DWT

Masahiro Iwahashi\*, Teerapong Orachon\* and Hitoshi Kiya†

\*Department of Electrical, Electronics and Information Engineering, Nagaoka University of Technology, Nagaoka, Niigata, Japan,

†Department of Information and Communication Systems, Faculty of System Design, Tokyo Metropolitan University Hino, Tokyo, Japan

**Abstract**— This report reduces the total number of lifting steps in a 3D quadruple lifting DWT (discrete wavelet transform). In the JPEG 2000 international standard, the 9/7 quadruple lifting DWT has been widely utilized for image data compression. It has been also applied to volumetric medical image data analysis. However, it has long delay from input to output due to cascading four (quadruple) lifting steps per dimension. We reduce the total number of lifting steps introducing 3D direct memory accessing under the constraint that it has backward compatibility with the conventional DWT in JPEG 2000. As a result, the total number of lifting steps is reduced from 12 to 8 (67 %) without significant degradation of data compression performance.

## I. INTRODUCTION

The three dimensional (3D) discrete wavelet transform (DWT) has been applied for data compression of volumetric medical images [1], and for analysis of hyper spectral images [2]. It is constructed by cascading conventional 1D DWTs in three dimensions, e.g. width, height and depth. However it requires long delay from input to output, especially when the DWT is implemented in the lifting structure. In this report, we propose a low delay 3D ‘quadruple’ lifting DWT compatible with the conventional 9/7 DWT in JPEG 2000 [3].

In case of 2D image processing, a 1D DWT is applied twice (vertically and horizontally) to a 2D image signal. It is referred to the ‘separable’ 2D DWT, since its transfer function is expressed as a product of two 1D functions. This processing is widely utilized in conventional image processing systems, e.g. JPEG 2000, owing to its advantage that it requires simple 1D memory accessing [4].

However, the separable 2D DWT requires long delay especially when the 1D DWT is composed of cascading many lifting steps. This is because a lifting step must wait for a result of the former lifting step. In addition, its flexibility of directional filtering is also restricted. Therefore various ‘non-separable’ 2D DWTs have been investigated to make it free from restrictions of the separable 2D structure [5-12].

The separable ‘double’ lifting DWT (5/3 filter bank) in JPEG 2000 was extended to non-separable one in [6]. Introducing 2D memory accessing, the total number of lifting steps was reduced from 4 to 3 in one stage decomposition (into four bands: *LL*, *LH*, *HL* and *HH*). It was extended to the ‘quadruple’ lifting DWT (9/7 filter bank) in [7]. The lifting steps were furthermore reduced in [8]. Its performance was

investigated from various point of views in [9,10]. Even though these non-separable 2D DWTs have widely applied for more flexible filtering in [11, 12], only few attempts have so far been made at the 3D signal processing case.

Therefore, we extend the previous discussions on 2D case to 3D case. Recently, we invented a non-separable DWT in [13]. However, it was limited to ‘double’ lifting DWT especially utilized for lossless coding. In this report, we propose a non-separable ‘quadruple’ lifting DWT widely utilized for lossy coding and analysis of volumetric data.

It is indicated that the total number of lifting steps is reduced from 12 to 8 (67 %). We also confirm that the proposed 3D DWT has acceptable compatibility with the conventional separable 3D DWT.

## II. PREVIOUS WORKS

### A. Two Dimensional (2D) ‘Quadruple’ Lifting DWT

Fig.1 illustrates the separable 2D ‘quadruple’ lifting DWT. Pixels in the original image are classified into four groups  $\{X_{00}, X_{01}, X_{10}, X_{11}\}$  according to their locations. In the first lifting step, a pixel value in  $X_{10}$  is predicted from neighboring pixels in  $X_{00}$ . Predictions from  $X_{01}$  to  $X_{11}$  are also performed at the same timing as illustrated in Fig.2(a). After waiting for the results of the 1st step, predictions in the 2nd step is performed. Since this ‘separable’ structure has eight lifting steps, it has long delay from the input  $\{X_{00}, X_{01}, X_{10}, X_{11}\}$  to the output band signals  $\{LL, LH, HL, HH\}$ .

To reduce the total number of lifting step, a non-separable 2D ‘quadruple’ lifting DWT (type I) was reported in [7]. Subsequently, its lifting steps were furthermore reduced (type II) in [8,9]. As illustrated in Fig.3, it has six lifting steps in total. Therefore, the total number of lifting steps was reduced from 8 to 6 as summarized in table I.

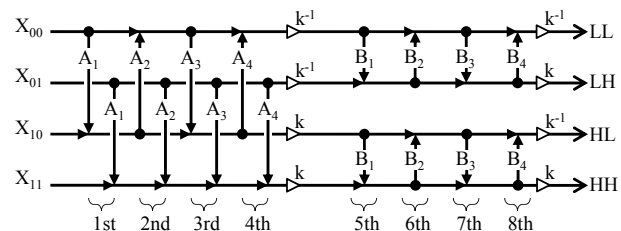

Fig.1 Separable 2D ‘quadruple’ lifting DWT.

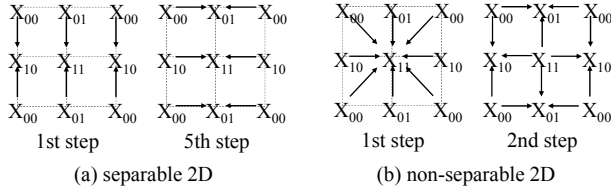

Fig.2 Predictions in the 2D lifting DWT.

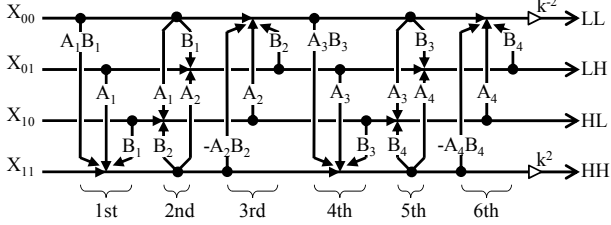

Fig.3 Non-separable 2D 'quadruple' lifting DWT (type II).

Table I Comparison among the DWTs.

criteria		rounding operations		lifting steps		
		lifting	double	quadruple	double	quadruple
2D	separable		4	16	4	8
	non separable	type I	4	12	3	7
		type II	---	8	---	6
3D	separable		24	48	6	12
	non separable		8	16	4	8

### B. Expression in z-Transform Domain

Procedures of the signal processing in the DWT are described in the z-transform domain as follows. Using the 2D z-transform:

$$X(z_1, z_2) = X(\mathbf{z}) = \sum_{n_2=0}^{N_2-1} \sum_{n_1=0}^{N_1-1} x(n_1, n_2) z_1^{-n_1} z_2^{-n_2} \quad (1)$$

for a pixel value  $x(n_1, n_2)$  at location  $(n_1, n_2)$  of the original image signal, the four groups are classified [10] as

$$\begin{bmatrix} X_{00}(\mathbf{z}) \\ X_{01}(\mathbf{z}) \end{bmatrix} = \begin{bmatrix} D_2[X_0(\mathbf{z})] \\ D_2[X_0(\mathbf{z})z_2] \end{bmatrix}, \begin{bmatrix} X_{10}(\mathbf{z}) \\ X_{11}(\mathbf{z}) \end{bmatrix} = \begin{bmatrix} D_2[X_1(\mathbf{z})] \\ D_2[X_1(\mathbf{z})z_2] \end{bmatrix} \quad (2)$$

for

$$\begin{bmatrix} X_0(\mathbf{z}) \\ X_1(\mathbf{z}) \end{bmatrix} = \begin{bmatrix} D_1[X(\mathbf{z})] \\ D_1[X(\mathbf{z})z_1] \end{bmatrix},$$

$$\begin{bmatrix} D_1[X(\mathbf{z})] \\ D_2[X(\mathbf{z})] \end{bmatrix} = \begin{bmatrix} \{X(z_1^{1/2}, z_2) + X(-z_1^{1/2}, z_2)\}/2 \\ \{X(z_1, z_2^{1/2}) + X(z_1, -z_2^{1/2})\}/2 \end{bmatrix}.$$

The predictions are performed with the finite impulse response (FIR) filters:

$$\begin{bmatrix} A_1 & A_3 \\ A_2 & A_4 \end{bmatrix} = \mathbf{H}(z_1), \begin{bmatrix} B_1 & B_3 \\ B_2 & B_4 \end{bmatrix} = \mathbf{H}(z_2) \quad (3)$$

for

$$\mathbf{H}(z_d) = \begin{bmatrix} 1+z_d^{-1} & 0 \\ 0 & 1+z_d^{-1} \end{bmatrix} \begin{bmatrix} h_1 & h_3 \\ h_2 & h_4 \end{bmatrix} \quad (4)$$

and

$$\begin{cases} h_1 = -1.586134342059924, & h_2 = -0.052980118572961, \\ h_3 = 0.882911075530934, & h_4 = 0.443506852043971, \\ k = 1.230174104914001 \end{cases} \quad (5)$$

as specified in the JPEG 2000 international standard. In case of (4), each FIR filter has four tap and symmetry. The number of tap can be extended to more than four [9].

### C. Separable 3D DWT (Existing Method)

Similarly to Fig.1, a separable 3D DWT is implemented as illustrated in Fig.6. Predictions in the 3D lifting steps are performed as illustrated in Fig.4 similarly to Fig.2(a). Note that pixels in the original image are classified into eight groups  $\{X_{000}, X_{001}, X_{010}, X_{011}, X_{100}, X_{101}, X_{110}, X_{111}\}$  and decomposed into eight frequency band signals  $\{LLL, LLH, LHL, LHH, HLL, HLH, HHL, HHH\}$  by adding one more dimensional filtering:

$$\begin{bmatrix} C_1 & C_3 \\ C_2 & C_4 \end{bmatrix} = \mathbf{H}(z_3). \quad (6)$$

As illustrated in Fig.6, it has twelve lifting steps in total. We are going to reduce this number in the next section.

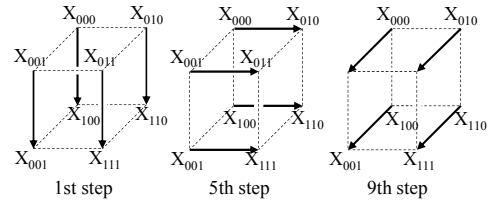

Fig.4 Predictions in the separable 3D lifting DWT.

## III. NON-SEPARABLE 3D WAVELET

Unlike the predictions of the 'separable' 3D DWT in Fig.4, we introduce the predictions based on the 3D direct memory accessing illustrated in Fig.5. The proposed 'non-separable' 3D DWT is illustrated in Fig.7. As clearly indicated, the total number of lifting steps is reduced from 12 of the existing method in Fig.6 to 8 of the proposed method in Fig.7. It is guaranteed that the output band signals in the proposed DWT are exactly the same as those of the existing DWT in case of numerical rounding errors are negligible. In this sense, the proposed 'non-separable' 3D DWT has full compatibility with the existing 'separable' one.

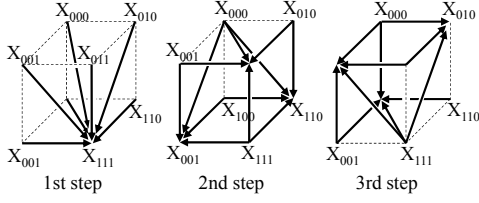

Fig. 5 Predictions in the non-separable 3D lifting DWT.

Fig. 5 (left) illustrates the prediction in the 1st lifting step of Fig. 7. Its prediction error is calculated as

$$e_{111}(\mathbf{z}) = X_{111}(\mathbf{z}) + R_S[\hat{X}_{111}(\mathbf{z})] \quad (7)$$

for

$$\hat{X}_{111}(\mathbf{z}) = A_1 B_1 C_1 X_{000}(\mathbf{z}) + A_1 B_1 X_{001}(\mathbf{z}) + A_1 C_1 X_{010}(\mathbf{z}) + A_1 X_{011}(\mathbf{z}) + B_1 C_1 X_{100}(\mathbf{z}) + B_1 X_{101}(\mathbf{z}) + C_1 X_{110}(\mathbf{z})$$

where  $R_S[\ ]$  denotes rounding operation [14] defined as

$$R_S[x] = \text{round}(x \cdot 2^{F_s}) \cdot 2^{-F_s} \quad (8)$$

for a pixel value  $x$ . After completion of calculation in the 1st step, prediction in the 2nd step is performed as

$$\begin{cases} e_{110}(\mathbf{z}) = X_{110}(\mathbf{z}) + R_S[\hat{X}_{110}(\mathbf{z})] \\ e_{101}(\mathbf{z}) = X_{101}(\mathbf{z}) + R_S[\hat{X}_{101}(\mathbf{z})] \\ e_{011}(\mathbf{z}) = X_{011}(\mathbf{z}) + R_S[\hat{X}_{011}(\mathbf{z})] \end{cases} \quad (9)$$

for

$$\begin{cases} \hat{X}_{110}(\mathbf{z}) = A_1 B_1 X_{000}(\mathbf{z}) + A_1 X_{010}(\mathbf{z}) + B_1 X_{100}(\mathbf{z}) + C_2 X_{111}(\mathbf{z}) \\ \hat{X}_{101}(\mathbf{z}) = A_1 C_1 X_{000}(\mathbf{z}) + A_1 X_{001}(\mathbf{z}) + C_1 X_{100}(\mathbf{z}) + B_2 X_{111}(\mathbf{z}) \\ \hat{X}_{011}(\mathbf{z}) = B_1 C_1 X_{000}(\mathbf{z}) + B_1 X_{001}(\mathbf{z}) + C_1 X_{010}(\mathbf{z}) + A_2 X_{111}(\mathbf{z}) \end{cases}$$

These predictions can be performed without mutually waiting for each calculation result. The prediction in the 2nd step is illustrated in Fig. 5 (middle). Similarly, other lifting steps are performed as illustrated in Fig. 7.

Finally, as summarized in table I, the total number of lifting steps is reduced from 12 to 8 (67 [%]) in the quadruple lifting 3D DWT. Note that the number of rounding operations in (8) is also reduced from 48 to 16 (33 [%]).

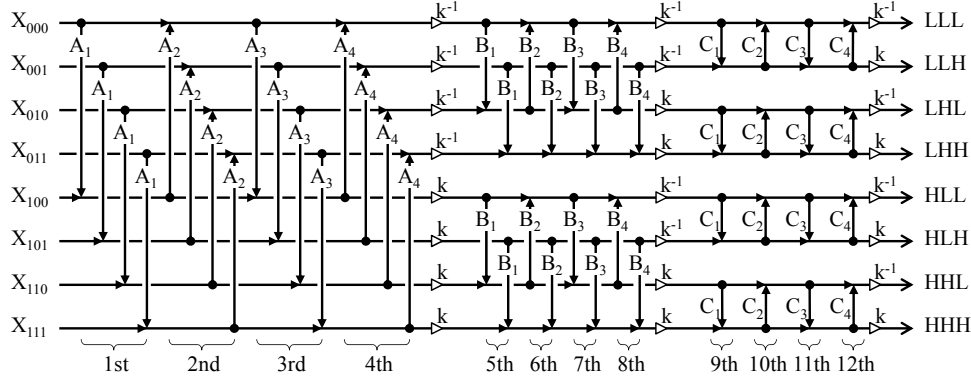

Fig. 6 Separable 3D structure of the quadruple DWT (existing method).

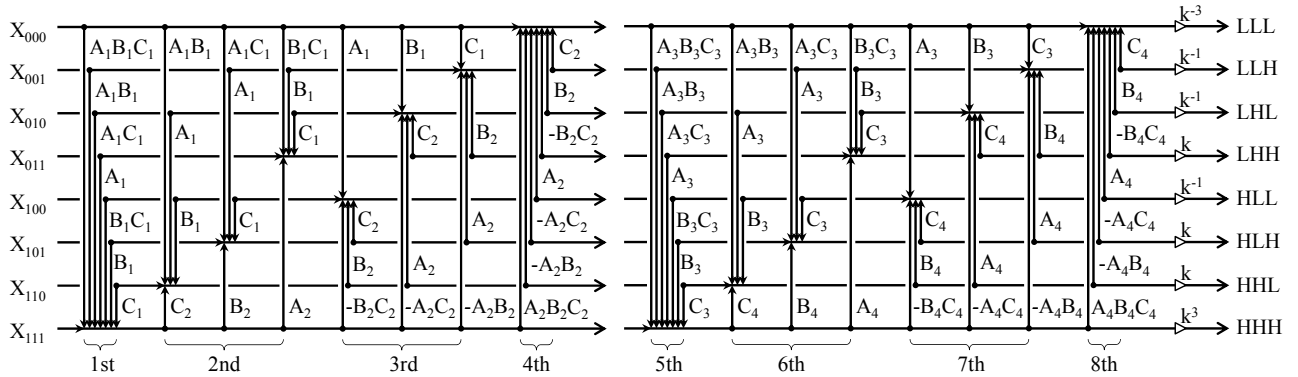

Fig. 7 Non-separable 3D structure of the quadruple DWT (proposed method).

#### IV. EXPERIMENTAL RESULTS

Fig.8 illustrates results of applying the 3D DWT to the CT scanned images provided by MATLAB. The original eight images are decomposed into four *LLL* band images as illustrated in the top-left in Fig.8. These images can be further more decomposed in the 2nd stage of the octave decomposition in the future (omitted here).

To confirm compatibility of the proposed DWT with the existing DWT, we calculated difference of the band signals between the existing method with  $F_S=64$  and the proposed (or existing) method with  $F_S$  indicated in the horizontal axis of Fig.9. The standard deviation of the difference was observed to be proportional to  $2^{-F_S}$ . We also investigated effect of shortening word length of filter coefficients in (5). It was observed that there is no significant difference between the two methods in their output signals according to Fig.10.

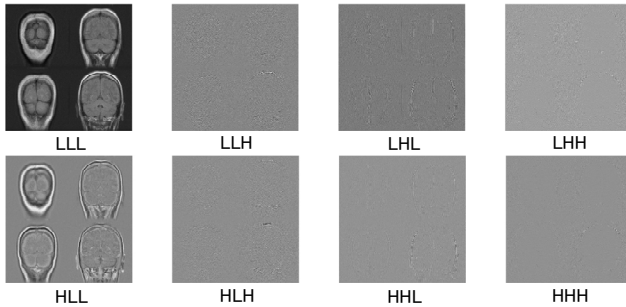

Fig.8 Results of applying the 3D DWT to eight CT images.

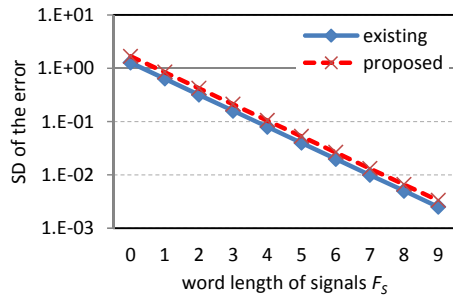

Fig.9 Effect of shortening word length of signal values.

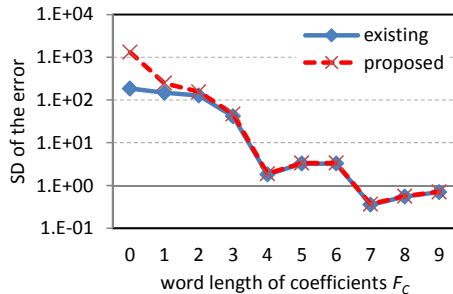

Fig.10 Effect of shortening word length of filter coefficients.

#### V. CONCLUSIONS

A non-separable 3D DWT compatible with the conventional separable 3D 'quadruple' lifting DWT was reported. Introducing 3D direct memory accessing, the total number of lifting steps was reduced from 12 to 8 (67 %). Derivation process of the proposed DWT, omitted here due to lack of space, will be opened in the near future.

#### REFERENCES

- [1] Z. Xiong, X. Wu, S. Cheng, J. Hua, "Lossy-to-Lossless Compression of Medical Volumetric Data using Three-Dimensional Integer Wavelet Transforms," *IEEE Trans Medical Imaging*, 22 (3), pp.459-70, 2003.
- [2] B. Penna, T. Tillo, E. Magli, G. Olmo, "Progressive 3-D Coding of Hyperspectral Images Based on JPEG 2000," *IEEE Geoscience, Remote Sensing Letters*, vol.3, 1, pp.125-129, 2006.
- [3] Joint Photographic Experts Group, "JPEG 2000 Image Coding System," ISO/IEC FCD 15444-1, 2000.
- [4] C. Chrysafis, A. Ortega, "Line-based, Reduced Memory, wavelet Image Compression," *IEEE Trans. Image Processing*, vol.9, no.3, pp.378-389, March 2000.
- [5] D. Taubman, "Adaptive, Non-separable lifting Transforms for Image Compression," *IEEE International Conference on Image Processing (ICIP)*, vol.3, pp.772-776, 1999.
- [6] S. Chokchaitam, M. Iwahashi, "Lossless / Lossy Image Compression Based on Non-Separable Two-Dimensional L-SSKF," *IEEE Intern'l Symposium, Circuits and Systems (ISCAS)*, pp.421-424, May 2002.
- [7] M. Iwahashi, H. Kiya, "Non Separable 2D Factorization of Separable 2D DWT for Lossless Image Coding," *IEEE Intern'l Conf., Image Processing (ICIP)*, pp.17-20, Nov. 2009.
- [8] M. Iwahashi, H. Kiya, "A New Lifting Structure of Non Separable 2D DWT with Compatibility to JPEG 2000", *IEEE Intern'l Conf. Acoustics, Speech, Signal Processing (ICASSP)*, pp.1306-1309, March 2010.
- [9] T. Strutz, I. Rennert, "Two-dimensional Integer Wavelet Transform with Reduced Influence of Rounding Operations," *EURASIP Journal, Advances in Signal Processing*, vol. 2012, Issue 1, pp.1-18, April 2012.
- [10] M. Iwahashi, H.Kiya, "Discrete Wavelet Transforms: Non Separable Two Dimensional Discrete Wavelet Transform for Image Signals", *InTech*, Chapter 1, pp.3-25, Feb.6, 2013.
- [11] M. Kaaniche, J. C. Pesquet, A. B. Benyahia, and B. P. Popescu, "Two-dimensional Non Separable Adaptive Lifting Scheme for Still and Stereo Image Coding," *IEEE Intern'l Conf. Acoustics, Speech and Signal Processing (ICASSP)*, pp.1298-1301, 2010.
- [12] Yoshida, T., Suzuki, T., Kyochi, S., Ikehara, M, "Two Dimensional Non-separable Adaptive Directional Lifting Structure of discrete Wavelet Transform," *IEEE International Conference on Acoustics, Speech, Signal Processing (ICASSP)*, pp.1529-1532, May, 2011.
- [13] M. Iwahashi, T. Orachon, H. Kiya, "Three Dimensional Discrete Wavelet Transform with Deduced Number of Lifting Steps," *IEEE International Conference on Image Processing (ICIP)*, Sept. 2013 (to be published).
- [14] M. Iwahashi, H. Kiya, "Discrete Wavelet Transforms: Condition on Word Length of Signals and Coefficients for DC Lossless Property", *InTech*, ISBN 978-953-307-313-2, Chapter 14, pp.231-254, Sept. 2011.